

# FPM-300/FLS-300/FOT-300

Power Meter/Light Source/Optical  
Loss Test Set



---

Copyright © 2003–2011 EXFO Inc. All rights reserved. No part of this publication may be reproduced, stored in a retrieval system or transmitted in any form, be it electronically, mechanically, or by any other means such as photocopying, recording or otherwise, without the prior written permission of EXFO Inc. (EXFO).

Information provided by EXFO is believed to be accurate and reliable. However, no responsibility is assumed by EXFO for its use nor for any infringements of patents or other rights of third parties that may result from its use. No license is granted by implication or otherwise under any patent rights of EXFO.

EXFO's Commerce And Government Entities (CAGE) code under the North Atlantic Treaty Organization (NATO) is 0L8C3.

The information contained in this publication is subject to change without notice.

### ***Trademarks***

EXFO's trademarks have been identified as such. However, the presence or absence of such identification does not affect the legal status of any trademark.

### ***Units of Measurement***

Units of measurement in this publication conform to SI standards and practices.

### ***Patents***

EXFO's Universal Interface is protected by US patent 6,612,750.

Version number: 6.0.0

# Contents

Certification Information .....	v
<b>1 Introducing the FPM-300/FLS-300/FOT-300 .....</b>	<b>1</b>
Main Features .....	1
Power Sources .....	3
Typical Applications .....	3
Conventions .....	3
<b>2 Safety Information .....</b>	<b>4</b>
Electrical Safety Information .....	4
Laser Safety Information (FLS-300 and FOT-300) .....	4
<b>3 Getting Started .....</b>	<b>6</b>
Turning the Unit On and Off .....	6
Activating Automatic Shutdown (Auto-Off) .....	7
Installing the EXFO Universal Interface (EUI) .....	7
Cleaning and Connecting Optical Fibers .....	8
<b>4 Measuring Power or Loss (FPM-300 and FOT-300) .....</b>	<b>9</b>
Nulling Electrical Offsets .....	9
Defining a List of Favorite Wavelengths .....	10
Referencing Your Power Meter to a Source .....	11
Measuring Power or Loss .....	13
Automatically Detecting Wavelength .....	15
<b>5 Using a Light Source (FLS-300 and FOT-300) .....</b>	<b>16</b>
Activating/Deactivating a Light Source .....	16
Modulating the Source Signal .....	16
Sending Source Power Value with Signal .....	17
<b>6 Maintenance .....</b>	<b>19</b>
Cleaning EUI Connectors .....	20
Cleaning Fixed Connectors .....	22
Cleaning Detector Ports .....	24
Replacing Batteries .....	24
Recalibrating the Unit .....	25
Recycling and Disposal (Applies to European Union Only) .....	25
<b>7 Troubleshooting .....</b>	<b>26</b>
Solving Common Problems .....	26
Error Codes and Descriptions .....	26
Contacting the Technical Support Group .....	27
Transportation .....	27
<b>8 Warranty .....</b>	<b>28</b>
General Information .....	28
Liability .....	28
Exclusions .....	29
Certification .....	29
Service and Repairs .....	30
EXFO Service Centers Worldwide .....	31
<b>A Technical Specifications .....</b>	<b>32</b>

---

## Certification Information

### Federal Communications Commission (FCC) and Industry Canada Information

Electronic test and measurement equipment is exempt from FCC part 15, subpart B compliance in the United States of America and from ICES-003 compliance in Canada. However, EXFO Inc. makes reasonable efforts to ensure compliance to the applicable standards.

The limits set by these standards are designed to provide reasonable protection against harmful interference when the equipment is operated in a commercial environment. This equipment generates, uses, and can radiate radio frequency energy and, if not installed and used in accordance with the user guide, may cause harmful interference to radio communications. Operation of this equipment in a residential area is likely to cause harmful interference in which case the user will be required to correct the interference at his own expense.

Modifications not expressly approved by the manufacturer could void the user's authority to operate the equipment.

### CE Information

Electronic test equipment is subject to the EMC Directive in the European Union. The IEC 61326-1 standard prescribes both emission and immunity requirements for laboratory, measurement, and control equipment. This unit has undergone extensive testing according to the European Union Directive and Standards.

## DECLARATION OF CONFORMITY

Application of Council Directive(s): 2006/95/EC – The Low Voltage Directive  
2004/108/EC – The EMC Directive  
93/68/EEC – CE Marking  
And their amendments

Manufacturer's Name and Address: **EXFO Inc.**  
400 Godin Avenue  
Quebec City, Quebec  
G1M 2K2 CANADA  
Tel.: +1 418 683-0211

**EXFO Europe**  
Omega Enterprise Park, Electron Way  
Chandlers Ford, Hampshire  
SO53 4SE ENGLAND  
Tel.: +44 2380 246810

Equipment Type/Environment: Test & Measurement / Industrial  
Trade Name/Model No.: Light Source / FLS-300, Optical Loss Test Set / FOT-300, Power Meter / FPM-300

Standard(s) to which Conformity is declared:

**EN 61010-1:2001 Edition 2.0** Safety requirements for electrical equipment for measurement, control, and laboratory use – Part 1: General requirements

**EN 61326-1:2006** Electrical equipment for measurement, control and laboratory use – EMC requirements – Part 1: General requirements

**EN 60825-1:2007 Edition 2.0** Safety of laser products – Part 1: Equipment classification and requirements

I, the undersigned, hereby declare that the equipment specified above conforms to the above Directive and Standards.

Manufacturer:



*Stephen Bull, E. Eng*  
Vice-President Research and Development

400 Godin Avenue,  
Quebec City, Quebec  
G1M 2K2 CANADA  
February 03, 2009



# 1 Introducing the FPM-300/FLS-300/FOT-300

This user guide covers the following products (unless otherwise specified, descriptions apply to all):

- FPM-300 Power Meter
- FLS-300 Light Source
- FOT-300 Optical Loss Test Set: combines both a power meter and a light source

## Main Features

	FPM	FLS	FOT
Ge or GeX detector with 10 calibrated wavelengths	X		X
Absolute power and link loss measurements	X		X
Editable list of favorite power meter wavelengths	X		X
Editable list of favorite source wavelengths			X
Automatic wavelength detection	X		X
No offset nulling of detectors required in normal operation	X		X
Multiple source configurations on a single port [FOT-300] or on one or two ports [FLS-300]		X	X
Transmission of editable power value with source's signal for automatic reference with compatible power meter		X	X
Transmission of wavelength to compatible power meter in automatic wavelength or auto-switching mode		X	X
Modulated signal emission or detection (270 Hz, 1 kHz and 2 kHz) compatible with other EXFO units	X	X	X
Automatic shutdown after 10 minutes of idle time (auto-off)	X	X	X

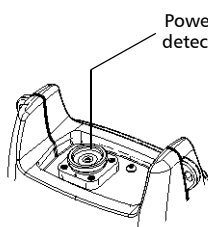
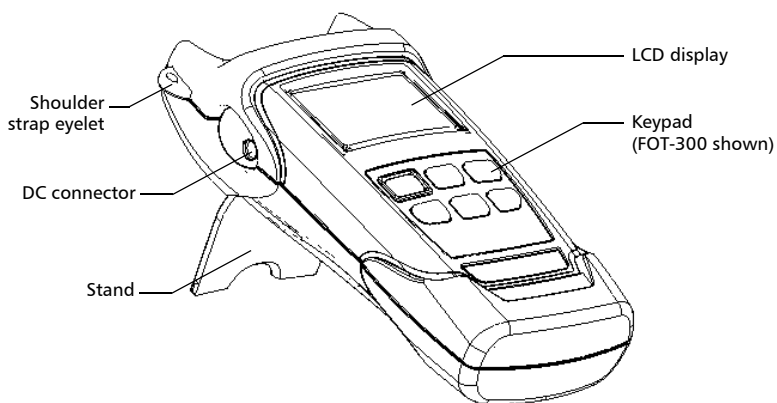

**FPM-300**

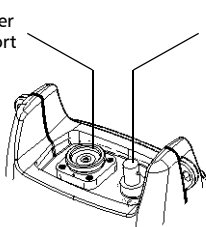

**FOT-300**

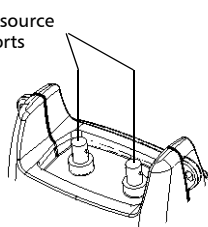

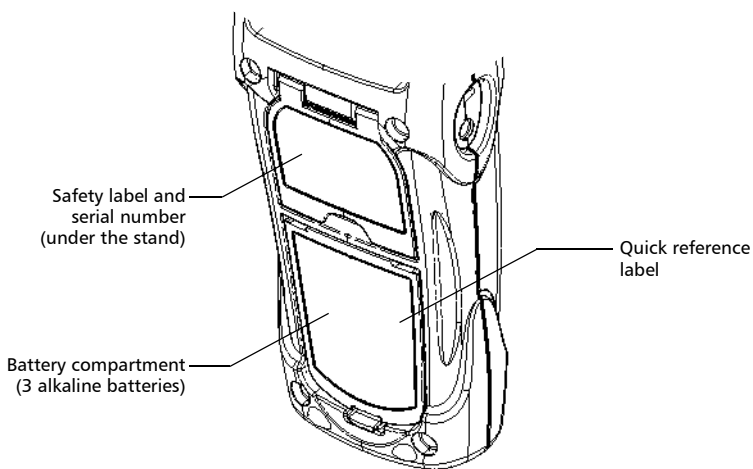

**FLS-300**



## Power Sources

The units operate with the following power sources:

- ▶ AC adapter (connected to standard power outlet—indoor use only)   
Compatible car outlet adapter available upon request.
- ▶ AA alkaline batteries (automatically take over if you unplug the AC adapter) 



### IMPORTANT

If the battery level becomes too low, the unit turns itself off.

## Typical Applications

- ▶ Transmitter power measurements (dBm and W)
- ▶ Fiber-link loss testing (dB)
- ▶ Component insertion-loss testing (dB)
- ▶ Fiber identification with 270-Hz, 1-kHz and 2-kHz signals
- ▶ Fiber installation and maintenance applications
- ▶ FTTx: testing of passive optical networks (PONs)

## Conventions

Before using the product described in this guide, you should understand the following conventions:



### WARNING

Indicates a potentially hazardous situation which, if not avoided, could result in *death or serious injury*. Do not proceed unless you understand and meet the required conditions.



### CAUTION

Indicates a potentially hazardous situation which, if not avoided, may result in *minor or moderate injury*. Do not proceed unless you understand and meet the required conditions.



### CAUTION

Indicates a potentially hazardous situation which, if not avoided, may result in *component damage*. Do not proceed unless you understand and meet the required conditions.



### IMPORTANT

Refers to information about this product you should not overlook.



## 2 Safety Information



### IMPORTANT



When you see the following symbol on your unit , make sure that you refer to the instructions provided in your user documentation. Ensure that you understand and meet the required conditions before using your product.

### Electrical Safety Information



### WARNING

Use the AC adapter provided with this product *indoors only*.

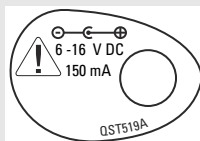

### WARNING

Do not use the unit outdoors in wet locations.

### Laser Safety Information (FLS-300 and FOT-300)



### WARNING

Use of controls, adjustments and procedures for operation and maintenance other than those specified herein may result in hazardous radiation exposure.



### WARNING

Do not install or terminate fibers while a laser source is active. Never look directly into a live fiber and ensure that your eyes are protected at all times.

Your instrument is a Class 1 laser product in compliance with standards IEC 60825-1 and 21 CFR 1040.10. Laser radiation may be encountered at the output port.

The following label indicates that a product contains a Class 1 source:

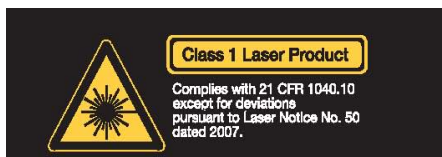

<b>Equipment Ratings</b>	
Temperature	
➤ Operation	-10 °C to 50 °C (14 °F to 122 °F)
➤ Storage	-40 °C to 70 °C (-40 °F to 158 °F)
Relative humidity	0 % to 95 % non-condensing
Maximum operation altitude	2000 m (6562 ft)
Pollution degree	2 (unit used inside; connected to AC mains or powered by batteries) <sup>a</sup> 3 (unit used outside; powered by batteries) <sup>b</sup>
Overvoltage category	II
Powersupply rating	100 V to 240 V (50 Hz/60 Hz) Maximum input current 0.12 A

a. Use the external power supply indoors only.

b. Equipment should be normally protected against exposure to direct sunlight, precipitations and full wind pressure.

# 3 Getting Started

## Turning the Unit On and Off

When you turn off the FPM-300 or the FOT-300, it saves the current wavelength, unit and reference power.



### IMPORTANT

If you remove batteries (and the AC adapter is unplugged), the unit will turn off *without saving the above values*.

If batteries are low (and the AC adapter is unplugged), the unit will save the above values and turn off.

**Note:** Offset nulling values are always returned to factory settings.

#### To turn on the unit:

Press . The unit displays **EXFO Inc.** for a few seconds. You may use it immediately under normal conditions.

#### To turn off the unit:

From normal operating mode (that is, not FAV or PREF), hold down  a few seconds.

### Display

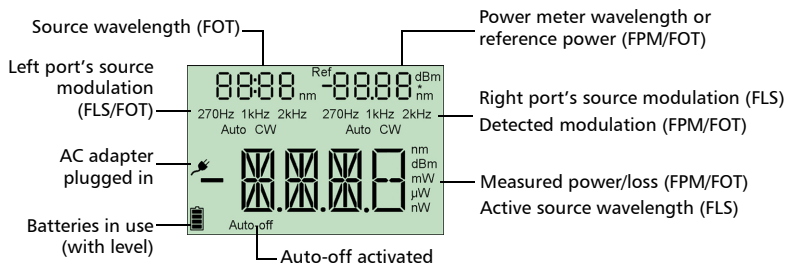

### Keypad

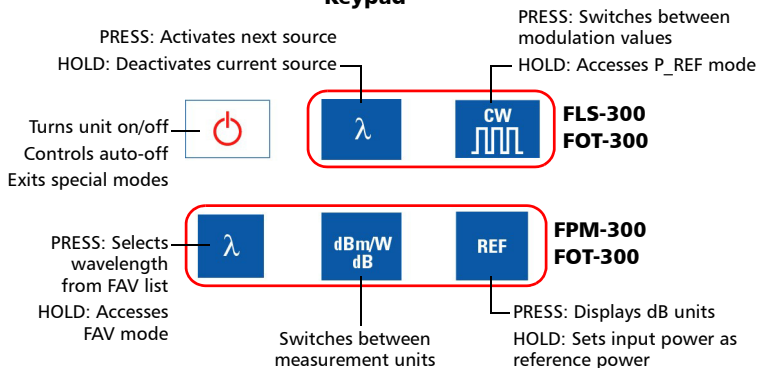

## Activating Automatic Shutdown (Auto-Off)

When auto-off is activated, the unit will turn off after 10 minutes of idle time.

Auto-off is activated by default when you turn on the unit.

### To deactivate/reactivate auto-off:

When unit is on, press .

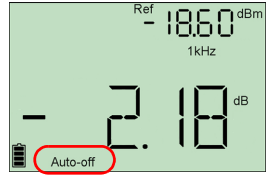

## Installing the EXFO Universal Interface (EUI)

The EUI fixed baseplate is available for connectors with angled (APC) or non-angled (UPC) polishing. A green border around the baseplate indicates that it is for APC-type connectors.

Green border  
indicates APC  
option

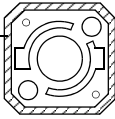

Bare metal  
(or blue border)  
indicates UPC option

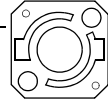

### To install an EUI connector adapter onto the EUI baseplate:

1. Hold the EUI connector adapter so the dust cap opens downwards.

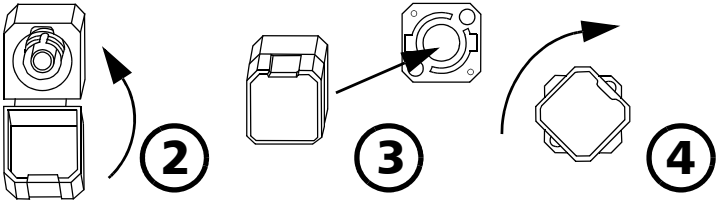

2. Close the dust cap in order to hold the connector adapter more firmly.
3. Insert the connector adapter into the baseplate.
4. While pushing firmly, turn the connector adapter clockwise on the baseplate to lock it in place.

# Cleaning and Connecting Optical Fibers



## IMPORTANT

To ensure maximum power and to avoid erroneous readings:

- Always clean fiber ends as explained below before inserting them into the port. EXFO is not responsible for damage or errors caused by bad fiber cleaning or handling.
- Ensure that your patchcord has appropriate connectors. Joining mismatched connectors will damage the ferrules.

### **To connect the fiber-optic cable to the port:**

1. Inspect the fiber using a fiber inspection microscope. If the fiber is clean, proceed to connecting it to the port. If the fiber is dirty, clean it as explained below.
2. Clean the fiber ends as follows:
  - 2a. Gently wipe the fiber end with a lint-free swab dipped in isopropyl alcohol.
  - 2b. Use compressed air to dry completely.
  - 2c. Visually inspect the fiber end to ensure its cleanliness.
3. Carefully align the connector and port to prevent the fiber end from touching the outside of the port or rubbing against other surfaces.

If your connector features a key, ensure that it is fully fitted into the port's corresponding notch.
4. Push the connector in so that the fiber-optic cable is firmly in place, thus ensuring adequate contact.

If your connector features a screwsleeve, tighten the connector enough to firmly maintain the fiber in place. Do not overtighten, as this will damage the fiber and the port.

**Note:** *If your fiber-optic cable is not properly aligned and/or connected, you will notice heavy loss and reflection.*

## 4 Measuring Power or Loss (FPM-300 and FOT-300)

### Nulling Electrical Offsets

Temperature and humidity variations affect the performance of electronic circuits and optical detectors. Nulling the electrical offsets eliminates these effects. *Your unit has been designed not to require offset nulling under normal operation*, but you should perform it whenever environmental conditions change significantly or when measuring very low power values.



#### IMPORTANT

If light reaches the detector when nulling offsets, **LIGH** appears on the display and the nulling is not performed. You will need to press a key to return to the previous display.

**Note:** *Factory-defined values will be reinstated when you turn off the unit.*

#### To perform an offset nulling:

Hold down  $\frac{\text{dBm/W}}{\text{dB}}$  and  $\lambda$  (power meter) a few seconds. The unit displays **NULL** while nulling the offsets, then returns to normal mode.

**Note:** *Keypad is disabled during the operation.*



## Defining a List of Favorite Wavelengths

You must put the wavelengths you want to use on a list of favorite wavelengths (the FAV list). Only wavelengths on this list are available for measurements.

At the factory (or after recalibration), the list contains 10 calibrated wavelengths.

**Note:** *The list must always contain at least one wavelength.*

### To add wavelengths to the FAV list (or to remove them):

1. Hold down  $\lambda$  (power meter) a few seconds. The unit enters the FAV list and displays the current wavelength.
2. Press  $\lambda$  (power meter) to switch between available wavelengths. An asterisk (\*) appears beside wavelengths already on the list.
3. Press  $\frac{\text{dBm/W}}{\text{dB}}$  to include/exclude the displayed wavelength.
4. Repeat steps 2 to 3 for other wavelengths as necessary.
5. Press  $\text{Power}$  to return to normal mode. If your list is empty, the unit beeps and you cannot exit the FAV list.

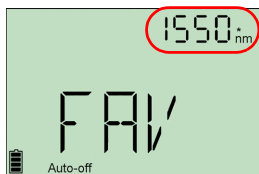

## Referencing Your Power Meter to a Source

In reference mode, your unit displays the loss created by the fiber under test only, since a reference value is subtracted from the measured power.

**Note:** You must set a reference value separately for each wavelength.

Compatible sources (such as FOT-300 and FLS-300) can transmit a power value to your power meter, avoiding the need for manual referencing.



### IMPORTANT

The value sent is not the source's actual power. It is a user-defined value that may not take the optical link's loss into account.

#### To receive the reference power value from a compatible source:

1. Connect a compatible source to your power meter (as shown below, with or without a fiber under test).
2. Use the source to emit the signal that contains its power value (see *To change the signal modulation:* on page 16).
  - If reference value or units change, the power meter beeps and displays **REF** while detecting the special signal.
  - The new reference power is displayed in the top right corner (in dBm) and current loss reading is automatically switched to dB.

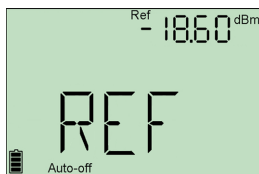

**Note:** When using this feature, you cannot change the power meter's wavelength, units or reference power manually. The power meter behavior is totally determined by the source.



### To reference the power meter to a source manually:

1. Using the proper adapter, connect a light source (such as FLS-300 or FOT-300) to the detector port of your power meter.

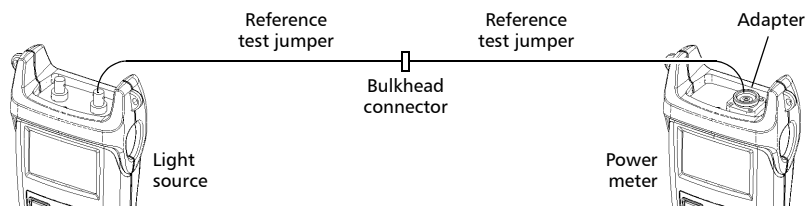

2. Activate the source at the desired wavelength.
3. Match the source and power meter wavelengths:

- If the source emits an auto-wavelength signal (see *Automatically Detecting Wavelength* on page 15), the power meter automatically matches the source wavelength.

4. Hold down **REF** for a few seconds. The power meter stores the currently detected power as the new reference power.

Reference power is displayed in the top right corner (in dBm) and current loss reading is automatically switched to dB.

5. Repeat the procedure for each wavelength you want to reference.

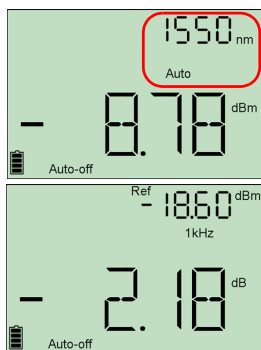

**Note:** When using dB units, press  $\lambda$  (power meter) to display the current wavelength for a few seconds. To change this wavelength, press  $\lambda$  again while it is displayed.

**Note:** Once all desired wavelengths have been referenced, do not disconnect the Reference Test Jumper from the source port.

## Measuring Power or Loss

Measuring absolute power or link loss is done the same way, except for the referencing step.

### To perform power or loss measurements:

1. If necessary, perform an offset nulling (see *Nulling Electrical Offsets* on page 9).
2. Check and clean your fibers appropriately for optimum performance (see *Cleaning and Connecting Optical Fibers* on page 8).
3. For loss measurements, reference your power meter to a light source (see *Referencing Your Power Meter to a Source* on page 11), then deactivate the light source.
4. Using the proper adapter and test jumpers, connect a fiber under test to a light source (such as FLS-300 or FOT-300) and to the detector port of your unit.

**Note:** *If you have referenced your power meter to a source, simply connect a fiber under test to the test jumpers used for referencing.*

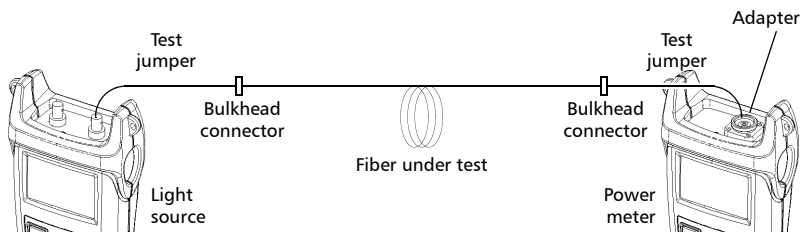

5. Activate the source at the desired wavelength.

6. Match the source and power meter wavelengths:

- If the source emits an auto-wavelength signal (see *Automatically Detecting Wavelength* on page 15), the power meter automatically matches the source wavelength.

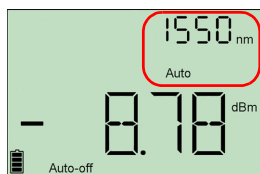

If the source emits an auto-wavelength signal or is in auto-switching mode (see *Automatically Detecting Wavelength* on page 15 and see *To receive the auto-wavelength signal or detect the source's auto-switching mode:* on page 15), the power meter automatically matches the source wavelength. OR

- Press  $\lambda$  (power meter) to switch between pre-selected wavelengths (see *Defining a List of Favorite Wavelengths* on page 10).

7. If you want to see a loss value and your power meter displays W or dBm units, press REF to access reference mode.

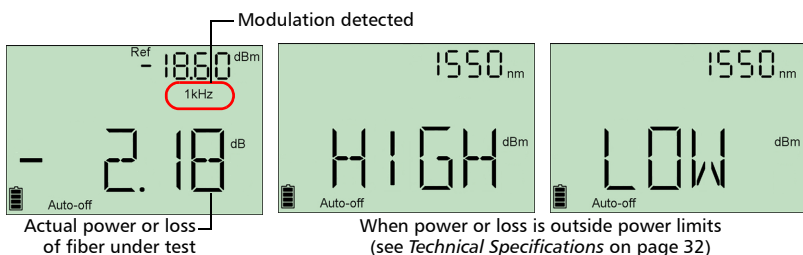

When the unit detects a modulated signal, it beeps and displays the modulation value and *average* measured power or loss (see left illustration above). You may notice a slightly unstable last digit.

- 8. If necessary, change the displayed units by pressing  $\frac{dBm}{W}$  /  $\frac{dB}{dB}$ .
- 9. Repeat the procedure for other wavelengths.

## Automatically Detecting Wavelength

Compatible sources (such as FOT-300 and FLS-300) can transmit their wavelength value through the fiber, avoiding the need to manually match the source and power meter wavelengths.

**Note:** *When you receive an auto-wavelength signal or when the source is in auto-switching mode, you cannot manually change the power meter wavelength. The power meter behavior is totally determined by the source.*

### To receive the auto-wavelength signal or detect the source's auto-switching mode:

1. Connect a compatible source to your power meter.
2. Activate the source in Auto mode (FOT-300 and FLS-300: see *Modulating the Source Signal* on page 16) or in auto-switching mode.

Your power meter automatically matches the source wavelength. If the wavelengths differ, it also beeps and returns you to normal operating mode.

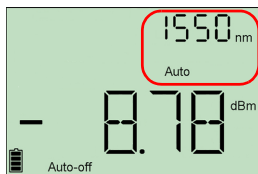

# 5 Using a Light Source (FLS-300 and FOT-300)

The FLS-300 may contain up to three sources (one-port models) or up to four sources (two-port models). The FOT-300 may contain up to three sources.

## Activating/Deactivating a Light Source

Only one source may be active at a time. When no source is active, the unit displays **NONE** (FLS-300) or leaves the top left corner empty (FOT-300).

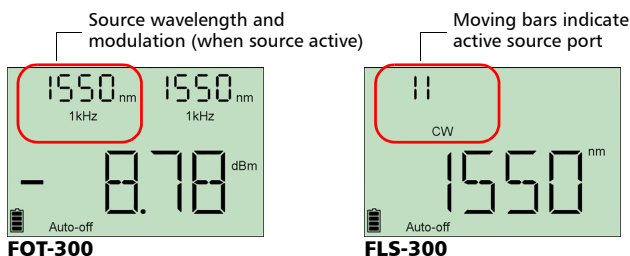

### To activate a light source and change the wavelength:

Press  $\lambda_{(\text{source})}$  to activate each available source in turn. The unit displays the wavelength and modulation.

### To deactivate the light source:

- Press  $\lambda_{(\text{source})}$  until you get past the last source.
- OR
- Hold down  $\lambda_{(\text{source})}$  a few seconds.

## Modulating the Source Signal

When you activate the first source, the signal is always CW (unmodulated). When you switch sources, the modulation remains the same. Modulation is indicated in the top left (port #1) or top right (port #2) corner.

Available modulation values are: CW, Auto, 270 Hz, 1 kHz and 2 kHz.

**Note:** *Auto is a modulated signal detected by compatible units (see Automatically Detecting Wavelength on page 15). It provides longer battery life than CW, but covers a reduced power range.*

### To change the signal modulation:

1. Activate the source.
2. Press  $\frac{\text{CW}}{\text{mod}}$  to switch between available modulations.

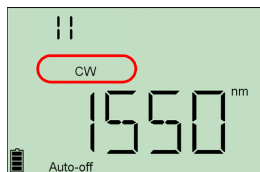

## Sending Source Power Value with Signal

Your source can transmit a user-defined power value to compatible power meters (such as FOT-300 and FPM-300) through the fiber. If the reference source is far from the power meter, you can connect your source to the power meter to send the reference value. With this feature you can also correct for power variations.

**Note:** *If you connect a fiber between FOT-300's source and detector ports, the unit can use the actual source output power as reference power.*

**Note:** *For details about how compatible power meters receive this power value, see Referencing Your Power Meter to a Source on page 11.*



### IMPORTANT



The value sent is not (and will not affect) the source's actual power. It is a user-defined value that may not take the optical link's loss into account.

- If the source emits an auto-wavelength signal (see *Automatically Detecting Wavelength* on page 15), the power meter automatically matches the source wavelength.

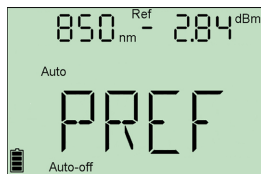

### To send the source power value:

1. Activate the source.
2. Hold down  a few seconds. The unit switches to **PREF** mode and displays the wavelength and transmittable power. The left/right modulation indicator identifies the current source port.
3. If necessary, edit the value to send.







- 3a. Press . The first digit of the power value blinks.
  - 3b. Revert to the *factory-default power value* by holding down  and  (source) a few seconds.

OR

Select a digit to change by pressing  (source) until it blinks, then increase its value by pressing  (it returns to 0 after 9). After the last digit, all digits blink. You may add/remove the “-” sign by pressing .

OR

[FOT-300 only] Hold down  to use the *actual source output power*. Ensure a fiber is connected between the source and power meter.

- 3c. Press  to save the modified value (the value remains in memory even when you turn the unit off).
  4. Press  (source) to send the power value with an auto-wavelength signal.
- OR
- Press  to return to normal mode without sending a power value.

**Note:** *If you are using a single FOT-300 with its source connected to its power meter, the power meter simply beeps when receiving the value, then returns to its previous display.*

## 6 Maintenance

This product contains no user-serviceable parts. However, it contains sensitive electronic and optical components, and should be handled carefully and stored in its carrying case when not in use.

To help ensure long, trouble-free operation:

- ▶ Always inspect fiber-optic connectors before using them and clean them if necessary.
- ▶ Keep the unit free of dust.
- ▶ Clean the unit casing and front panel with a cloth slightly dampened with water.
- ▶ Store unit at room temperature in a clean and dry area. Keep the unit out of direct sunlight.
- ▶ Avoid high humidity or significant temperature fluctuations.
- ▶ Avoid unnecessary shocks and vibrations.
- ▶ If any liquids are spilled on or into the unit, turn off the power immediately, disconnect from any external power source, remove the batteries and let the unit dry completely.



### WARNING

Use of controls, adjustments, and procedures for operation and maintenance other than those specified herein may result in hazardous radiation exposure.



# Cleaning EUI Connectors

Regular cleaning of EUI connectors will help maintain optimum performance. There is no need to disassemble the unit.



## IMPORTANT

If any damage occurs to internal connectors, the module casing will have to be opened and a new calibration will be required.

### To clean EUI connectors:

1. Remove the EUI from the instrument to expose the connector baseplate and ferrule.

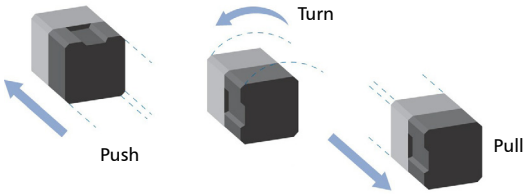

2. Moisten a 2.5 mm cleaning tip with *one drop* of isopropyl alcohol (alcohol may leave traces if used abundantly).
3. Slowly insert the cleaning tip into the EUI adapter until it comes out on the other side (a slow clockwise rotating movement may help).

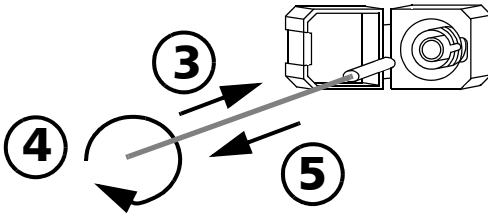

4. Gently turn the cleaning tip one full turn, then continue to turn as you withdraw it.

5. Repeat steps 3 to 4 with a dry cleaning tip.

**Note:** *Make sure you don't touch the soft end of the cleaning tip.*

6. Clean the ferrule in the connector port as follows:

- 6a. Deposit *one drop* of isopropyl alcohol on a lint-free wiping cloth.



## IMPORTANT

Since isopropyl alcohol is not absolutely pure, it may leave residues if used abundantly or left to evaporate (about 10 seconds).

Avoid contact between the tip of the bottle and the wiping cloth, dry the surface quickly, and use a bottle that distributes only a drop of alcohol at a time.

- 6b. Gently wipe the connector and ferrule.
- 6c. With a dry lint-free wiping cloth, gently wipe the same surfaces to ensure that the connector and ferrule are perfectly dry.
- 6d. Verify connector surface with a portable fiber-optic microscope (for example, EXFO's FOMS) or fiber inspection probe (for example, EXFO's FIP).



## WARNING

Verifying the surface of the connector **WHILE THE UNIT IS ACTIVE** **WILL** result in permanent eye damage.

7. Put the EUI back onto the instrument (push and turn clockwise).
8. Throw out cleaning tips and wiping cloths after one use.

## Cleaning Fixed Connectors

Regular cleaning of connectors will help maintain optimum performance. *Do not try to disassemble the unit. Doing so would break the connector.*

### **To clean fixed connectors:**

1. Fold a lint-free wiping cloth in four to form a square.
2. Moisten the center of the lint-free wiping cloth with *only one drop* of isopropyl alcohol.



### **IMPORTANT**

Alcohol may leave traces if used abundantly. Avoid contact between the tip of the bottle and the wiping cloth, and do not use bottles that distribute too much alcohol at a time.

3. Gently wipe the connector threads three times with the folded and moistened section of the wiping cloth.



### **IMPORTANT**

Isopropyl alcohol takes approximately ten seconds to evaporate. Since isopropyl alcohol is not absolutely pure, evaporation will leave microscopic residue. Make sure you dry the surfaces before evaporation occurs.

4. With a dry lint-free wiping cloth, gently wipe the same surfaces three times with a rotating movement.
5. Throw out the wiping cloths after one use.

- Moisten a cleaning tip (2.5 mm tip) with *only one drop* of isopropyl alcohol.



## IMPORTANT

Alcohol may leave traces if used abundantly. Avoid contact between the tip of the bottle and the cleaning tip, and do not use bottles that distribute too much alcohol at a time.

- Slowly insert the cleaning tip into the connector until it reaches the ferrule inside (a slow clockwise rotating movement may help).

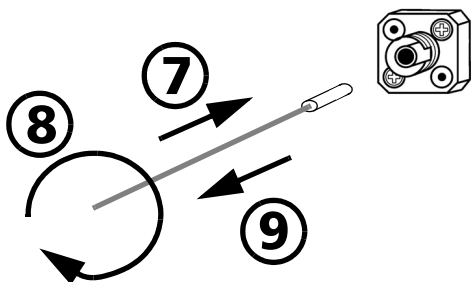

- Gently turn the cleaning tip one full turn.
  - Continue to turn as you withdraw the cleaning tip.
  - Repeat steps 7 to 9, but this time with a dry cleaning tip (2.5 mm tip provided by EXFO).
- Note:** *Make sure you don't touch the soft end of the cleaning tip and verify the cleanliness of the cotton tip.*
- Throw out the cleaning tips after one use.

## Cleaning Detector Ports

Regular cleaning of detectors will help maintain measurement accuracy.



### IMPORTANT

Always cover detectors with protective caps when unit is not in use.

#### To clean detector ports:

1. Remove the protective cap and adapter (FOA) from the detector.
2. If the detector is dusty, blow dry with compressed air.
3. Being careful not to touch the soft end of the swab, moisten a cleaning tip with *only one drop* of isopropyl alcohol.



### IMPORTANT

Alcohol may leave traces if used abundantly. Do not use bottles that distribute too much alcohol at a time.

4. While applying light pressure (to avoid breaking the detector window), gently rotate the cleaning tip on the detector window.
5. Repeat step 4 with a dry cleaning tip or blow dry with compressed air.
6. Discard the cleaning tips after one use.

## Replacing Batteries

Your unit requires three AA alkaline batteries.

**Note:** *The AC adapter (provided with the unit) is not a charger.*

#### To replace batteries:

1. Turn off the unit (if the AC adapter is plugged in, you may replace batteries while unit is on).
2. Open the battery compartment door located at the back of the unit.
3. Replace batteries, respecting the polarity as shown.
4. Close the battery compartment door.

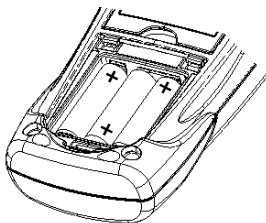

### WARNING

Do not throw batteries into fire or water and do not short-circuit the batteries' electrical contacts. Do not disassemble.

## Recalibrating the Unit





Manufacturing and service center calibrations are based on the ISO/IEC 17025 Standard, which states that calibration documents must not contain a recommended calibration interval, unless this has been previously agreed upon with the customer.

Validity of specifications depends on operating conditions. For example, the calibration validity period can be longer or shorter depending on the intensity of use, environmental conditions and unit maintenance. You should determine the adequate calibration interval for your unit according to your accuracy requirements.

Under normal use, EXFO recommends calibrating your unit every three years.

**Note:** *The FlexCare warranty program includes Calibration/Verification packages (see Service and Repairs on page 30).*

### To view the last calibration date (FOT-300 and FPM-300 only):

1. Hold down  (power meter) and press  at the same time. The unit displays the main embedded software version.
2. Press  (power meter) to display the calibration date of the power meter.
3. Press  to return to normal mode.

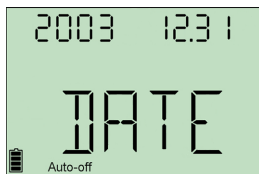

## Recycling and Disposal (Applies to European Union Only)

For complete recycling/disposal information as per European Directive WEEE 2002/96/EC, visit the EXFO Web site at [www.exfo.com/recycle](http://www.exfo.com/recycle).

# 7 Troubleshooting

## Solving Common Problems

Problem	Possible Cause	Solution
Unable to change power meter wavelength.	<ul style="list-style-type: none"><li>▶ Unit receiving Auto (or REF) signal from source.</li><li>▶ Only one wavelength in list.</li></ul>	Change source mode (see <i>Modulating the Source Signal</i> on page 16), then retry.  Add wavelengths.
Unable to change power meter dB unit or reference power. OR Changed unit or reference value are replaced by other values after a while.	Unit receiving REF signal from source. See <i>Press to switch between available modulations.</i> on page 16.	Wait a few seconds until power value is received, then retry.
Many beeps, unstable optical power and blinking <b>Auto</b> (or modulation) indicator.	Power too low to recognize Auto mode (or modulation).	Increase source power or switch source to CW.
Reference power different than source output power.	Received power outside detector's range.	Change source output power.

## Error Codes and Descriptions

- ▶ ER: error code displayed until you press a key.
- ▶ WR: warning code displayed for 3 seconds, then unit returns to normal.

Error Code	Description	Solution
LIGH	Light detected while nulling offsets. Nulling is not performed.	Correctly place protective cap on detector port, then retry.
10/11/22	Embedded software problem.	Contact EXFO.
13	EEPROM corrupted (would occur during unit initialization).	Unit must be recalibrated. Contact EXFO.
20	Wavelength sent from compatible source emitting in Auto mode is not available on your power meter.	Change source wavelength or switch source to CW.
28	Unstable optical power detected.	Increase source power in Auto mode, or switch source to CW.

## Contacting the Technical Support Group

To obtain after-sales service or technical support for this product, contact EXFO at one of the following numbers. The Technical Support Group is available to take your calls from Monday to Friday, 8:00 a.m. to 7:00 p.m. (Eastern Time in North America).

For detailed information about technical support, visit the EXFO Web site at [www.exfo.com](http://www.exfo.com).

### Technical Support Group



400 Godin Avenue  
Quebec (Quebec) G1M 2K2  
CANADA

1 866 683-0155 (USA and Canada)  
Tel.: 1 418 683-5498  
Fax: 1 418 683-9224  
[support@exfo.com](mailto:support@exfo.com)

To accelerate the process, please have information such as the name and the serial number (see the product identification label), as well as a description of your problem, close at hand.

You may also be requested to provide the embedded software's version numbers.

### To display the embedded software version:

1. Hold down  (power meter or source) and press  at the same time. The unit displays the main software version.
2. [FLS-300 and FOT-300] Press  (source) to switch between the main and the source's software versions.



Press  to return to normal mode.

## Transportation

Maintain a temperature range within specifications when transporting the unit. Transportation damage can occur from improper handling. The following steps are recommended to minimize the possibility of damage:

- Pack the unit in its original packing material when shipping.
- Avoid high humidity or large temperature fluctuations.
- Keep the unit out of direct sunlight.
- Avoid unnecessary shocks and vibrations.



# 8 Warranty

## General Information

EXFO Inc. (EXFO) warrants this equipment against defects in material and workmanship for a period of three years from the date of original shipment. EXFO also warrants that this equipment will meet applicable specifications under normal use.

During the warranty period, EXFO will, at its discretion, repair, replace, or issue credit for any defective product should the equipment need to be repaired. If the equipment is sent back for verification of calibration during the warranty period and found to meet all published specifications, EXFO will charge standard calibration fees.



### IMPORTANT

The warranty can become null and void if:

- unit has been tampered with, repaired, or worked upon by unauthorized individuals or non-EXFO personnel.
- warranty sticker has been removed.
- case screws, other than those specified in this guide, have been removed.
- case has been opened, other than as explained in this guide.
- unit serial number has been altered, erased, or removed.
- unit has been misused, neglected, or damaged by accident.

THIS WARRANTY IS IN LIEU OF ALL OTHER WARRANTIES EXPRESSED, IMPLIED, OR STATUTORY, INCLUDING, BUT NOT LIMITED TO, THE IMPLIED WARRANTIES OF MERCHANTABILITY AND FITNESS FOR A PARTICULAR PURPOSE. IN NO EVENT SHALL EXFO BE LIABLE FOR SPECIAL, INCIDENTAL, OR CONSEQUENTIAL DAMAGES.

## Liability

EXFO shall not be liable for damages resulting from the use of the product, nor shall be responsible for any failure in the performance of other items to which the product is connected or the operation of any system of which the product may be a part.

EXFO shall not be liable for damages resulting from improper usage or unauthorized modification of the product, its accompanying accessories and software.

## Exclusions

EXFO reserves the right to make changes in the design or construction of any of its products at any time without incurring obligation to make any changes whatsoever on units purchased. Accessories, including but not limited to fuses, pilot lamps, batteries and universal interfaces (EUI) used with EXFO products are not covered by this warranty.

This warranty excludes failure resulting from: improper use or installation, normal wear and tear, accident, abuse, neglect, fire, water, lightning or other acts of nature, causes external to the product or other factors beyond the control of EXFO.



### **IMPORTANT**

EXFO will charge a fee for replacing optical connectors that were damaged due to misuse or bad cleaning.

## Certification

EXFO certifies that this equipment met its published specifications at the time of shipment from the factory.

## Service and Repairs

EXFO commits to providing product service and repair for five years following the date of purchase.

### **To send any equipment for service or repair:**

1. Call one of EXFO's authorized service centers (see *EXFO Service Centers Worldwide* on page 31). Support personnel will determine if the equipment requires service, repair, or calibration.
2. If equipment must be returned to EXFO or an authorized service center, support personnel will issue a Return Merchandise Authorization (RMA) number and provide an address for return.
3. If possible, back up your data before sending the unit for repair.
4. Pack the equipment in its original shipping material. Be sure to include a statement or report fully detailing the defect and the conditions under which it was observed.
5. Return the equipment, prepaid, to the address given to you by support personnel. Be sure to write the RMA number on the shipping slip. *EXFO will refuse and return any package that does not bear an RMA number.*

**Note:** *A test setup fee will apply to any returned unit that, after test, is found to meet the applicable specifications.*

After repair, the equipment will be returned with a repair report. If the equipment is not under warranty, you will be invoiced for the cost appearing on this report. EXFO will pay return-to-customer shipping costs for equipment under warranty. Shipping insurance is at your expense.

Routine recalibration is not included in any of the warranty plans. Since calibrations/verifications are not covered by the basic or extended warranties, you may elect to purchase FlexCare Calibration/Verification Packages for a definite period of time. Contact an authorized service center (see *EXFO Service Centers Worldwide* on page 31).

---

## **EXFO Service Centers Worldwide**

If your product requires servicing, contact your nearest authorized service center.

### **EXFO Headquarters Service Center**

400 Godin Avenue  
Vanier (Quebec) G1M 2K2  
CANADA

1 866 683-0155 (USA and  
Canada)  
Tel.: 1 418 683-5498  
Fax: 1 418 683-9224  
support@exfo.com

### **EXFO Europe Service Center**

Omega Enterprise Park, Electron  
Way  
Chandlers Ford,  
Hampshire S053 4SE  
ENGLAND

Tel.: +44 2380 246810  
Fax: +44 2380 246801  
support.europe@exfo.com

### **EXFO Telecom Equipment (Shenzhen) Ltd.**

3rd Floor, Building 10,  
Yu Sheng Industrial Park (Gu Shu  
Crossing), No. 467,  
National Highway 107,  
Xixiang, Bao An District,  
Shenzhen, China, 518126

Tel: +86 (755) 2955 3100  
Fax: +86 (755) 2955 3101  
support.asia@exfo.com

# A Technical Specifications



## IMPORTANT

The following technical specifications can change without notice. The information presented in this section is provided as a reference only. To obtain this product's most recent technical specifications, visit the EXFO Web site at [www.exfo.com](http://www.exfo.com).

### SPECIFICATIONS<sup>a</sup>

Model <sup>b</sup>	FPM-302	FPM-302X
<b>Power meter port</b>	<b>Ge</b>	<b>GeX</b>
Power range <sup>c</sup> (dBm)	10 to -60	26 to -50
Range displayed <sup>d</sup> (dBm)	Down to -65	Down to -50
Number of calibrated wavelengths <sup>d</sup>	10	10
Power uncertainty <sup>e</sup>	± 5 % ± 1 nW	± 5 % ± 10 nW
Resolution (dB)	0.01 <sup>f</sup>	0.01 <sup>g</sup>
Automatic offset nulling <sup>h</sup>	Yes	Yes
Warmup time <sup>i</sup> (s)	0	0
Display units	dB/dBm/W	dB/dBm/W
Automatic wavelength recognition <sup>j</sup>	Yes	Yes
Screen refresh rate (Hz)	3	3
Tone detection (Hz)	270, 1 k, 2 k	270, 1 k, 2 k
Battery life (hours) (typical)	> 300	> 300
Warranty and recommended calibration interval (years)	3	3

### NOTES

- Guaranteed unless otherwise specified.
- All specifications valid at 1550 nm and 23 °C ± 1 °C, with an FC connector.
- In CW mode; sensitivity defined as 6 x rms noise level.
- Wavelengths: 830 nm, 850 nm, 980 nm, 1300 nm, 1450 nm, 1490 nm, 1550 nm, 1590 nm and 1625 nm.
- Traceable to NIST; FPM-302X: up to 20 dBm.
- From 10 dBm to -50 dBm.
- From 26 dBm to -35 dBm.
- Power of > -40 dBm for FPM-302, and of > -25 dBm for FPM-302X.
- For ± 0.05 dB and temperatures of > 18 °C.
- At 850 nm, 1300 nm, 1310 nm, 1490 nm, 1550 nm and 1625 nm; power of > -50 dBm for FPM-302, and of > -40 dBm (typical) for FPM-302X.

### GENERAL SPECIFICATIONS

Size (H x W x D)	18.5 cm x 10.0 cm x 5.5 cm	(7 1/4 in x 4 in x 2 1/8 in)
Weight	0.4 kg	(0.9 lb)
Temperature	operating storage	-10 °C to 50 °C (-40 °C to 70 °C)
Relative humidity	0 % to 95 % non-condensing	

### SPECIFICATIONS<sup>a</sup>

Model <sup>b</sup>	23BL	234BL	235BL	12D	01-VCL
Central wavelength (nm)	1310 ± 20	1310 ± 20	1310 ± 20	850 ± 25	850 +10/-20
	1550 ± 20	1550 ± 20	1490 ± 10	1300 +50/-10	
		1625 ± 15	1550 ± 20		
Spectral width <sup>c</sup> (nm)	≤5	≤5	≤5	50/135	≤1
Output power (dBm)	≥1/z1	≥1/z-3/z-5	≥1/z-4.5/z-3	≥-20/z-20 (62.5/125 μm)	≥-3 (50/125 μm)
Power stability <sup>d</sup> (dB)					
	8 hours	±0.10	±0.10	±0.10	±0.25
Battery life <sup>e</sup> (hours)	120	100	120	120	250
Enables automatic wavelength recognition	Yes	Yes	Yes	Yes	Yes
Tone generation (Hz)	270, 1 k, 2 k	270, 1 k, 2 k	270, 1 k, 2 k	270, 1 k, 2 k	270, 1 k, 2 k
Warranty and recommended calibration interval (years)	3	3	3	3	3

### GENERAL SPECIFICATIONS

Size (H x W x D)	18.5 cm x 10.0 cm x 5.5 cm	(7 1/4 in x 4 in x 2 1/8 in)
Weight	0.4 kg	(0.9 lb)
Temperature	operating storage	-10 °C to 50 °C (-40 °C to 70 °C)
Relative humidity	0 % to 95 % non-condensing	

### NOTES

- Guaranteed unless otherwise specified.
- All specifications valid at 23 °C ± 1 °C, with an FC connector.
- rms for lasers and -3 dB width for LEDs; typical values for LEDs.
- After 15 minutes warmup; expressed as ± half the difference between the maximum and minimum values measured during the period, with an APC connector on the power meter.
- Typical autonomy in Auto mode.

## SPECIFICATIONS <sup>a</sup>

Model	FOT-302	FOT-302X	
<b>Power meter port <sup>b</sup></b>	<b>Ge</b>	<b>GeX</b>	
Power range (dBm) <sup>c</sup>	10 to -60	26 to -50	
Range displayed (dBm)	Down to -65	Down to -50	
Number of calibrated wavelengths <sup>d</sup>	10	10	
Power uncertainty <sup>e</sup>	± 5 % ± 1 nW	± 5 % ± 10 nW	
Resolution (dB)	0.01 <sup>f</sup>	0.01g	
Automatic offset nulling <sup>h</sup>	Yes	Yes	
Warmup time (s) <sup>k, l</sup>	0	0	
Display units	dB/dBm/W	dB/dBm/W	
Automatic wavelength recognition <sup>l</sup>	Yes	Yes	
Screen refresh rate (Hz)	3	3	
Tone detection (Hz)	270, 1 k, 2 k	270, 1 k, 2 k	
Battery life (hours) (typical)	260	260	
Warranty and recommended calibration interval (years)	3	3	
<b>Model <sup>k</sup></b>	<b>23BL</b>	<b>12D</b>	<b>235BL</b>
Central wavelength (nm)	1310 ± 20 1550 ± 20	850 ± 25/ 1300 + 50/-10	1310 ± 20 1490 ± 10 1550 ± 20
Spectral width (nm) <sup>l</sup>	≤ 5	50/135	≤ 5
Output power (dBm)	≥ 1/≥ 1	≥ -20/≥ -20 (62.5/125 μm)	≥ 1/≥ -4.5/≥ -3
Power stability (dB) <sup>m</sup>	8 hours	± 0.1	± 0.1
Battery life (hours) <sup>n</sup>	120	120	120
Automatic wavelength recognition	Yes	Yes	Yes
Tone generation (Hz)	270, 1 k, 2 k	270, 1 k, 2 k	270, 1 k, 2 k
Warranty and recommended calibration interval (years)	3	3	3

## GENERAL SPECIFICATIONS

Size (H x W x D)	185 mm x 100 mm x 55 mm	(7 1/4 in x 4 in x 2 1/8 in)
Weight	0.4 kg	(0.9 lb)
Temperature	operating -10 °C to 50 °C storage -40 °C to 70 °C	(14 °F to 122 °F) (-40 °F to 158 °F)
Relative humidity	0 % to 95 % non-condensing	

### NOTES

- a. Guaranteed unless otherwise specified.
- b. All specifications valid at 1550 nm and 23 °C ± 1 °C, with an FC connector.
- c. In CW mode; sensitivity defined as 6 x rms noise level.
- d. Wavelengths: 830 nm, 850 nm, 980 nm, 1300 nm, 1310 nm, 1450 nm, 1490 nm, 1550 nm, 1590 nm and 1625 nm.
- e. Traceable to national standards; FOT-302X: up to 20 dBm.
- f. From 10 dBm to -50 dBm.
- g. From 26 dBm to -35 dBm.
- h. Power of > -40 dBm for FOT-302, and of > -25 dBm for FOT-302X.
- i. For ± 0.05 dB, from 18 °C to 28 °C.
- j. At 850 nm, 1300 nm, 1310 nm, 1490 nm, 1550 nm and 1625 nm; power > -50 dBm for FOT-302, and > -40 dBm (typical) for FOT-302X.
- k. All specifications valid at 23 °C ± 1 °C, with an FC connector.
- l. rms for lasers and -3 dB width for LEDs; typical values for LEDs.
- m. After 15 minutes warmup; expressed as ± half the difference between the maximum and minimum values measured during the period, with an APC connector on the power meter.
- n. Typical autonomy in Auto mode.

## NOTICE

### 通告

## CHINESE REGULATION ON RESTRICTION OF HAZARDOUS SUBSTANCES 中国关于危害物质限制的规定

NAMES AND CONTENTS OF THE TOXIC OR HAZARDOUS SUBSTANCES OR ELEMENTS  
CONTAINED IN THIS EXFO PRODUCT

包含在本 EXFO 产品中的有毒有害物质或元素的名称和含量



O	Indicates that this toxic or hazardous substance contained in all of the homogeneous materials for this part is below the limit requirement in SJ/T11363-2006 表示该有毒有害物质在该部件所有均质材料中的含量均在 SJ/T11363-2006 标准规定的限量要求以下。
X	Indicates that this toxic or hazardous substance contained in at least one of the homogeneous materials used for this part is above the limit requirement in SJ/T11363-2006 表示该有毒有害物质至少在该部件的某一均质材料中的含量超出 SJ/T11363-2006 标准规定的限量要求。

Part Name 部件名称	Toxic or hazardous Substances and Elements 有毒有害物质和元素					
	Lead 铅 (Pb)	Mercury 汞 (Hg)	Cadmium 镉 (Cd)	Hexavalent Chromium 六价铬 (Cr VI)	Polybrominated biphenyls 多溴联苯 (PBB)	Polybrominated diphenyl ethers 多溴二苯醚 (PBDE)
Enclosure 外壳	O	O	O	O	O	O
Electronic and electrical sub-assembly 电子和电子组件	X	O	X	O	X	X
Optical sub-assembly <sup>a</sup> 光学组件 <sup>a</sup>	X	O	O	O	O	O
Mechanical sub-assembly <sup>a</sup> 机械组件 <sup>a</sup>	O	O	O	O	O	O

a. If applicable.  
如果适用。

## MARKING REQUIREMENTS

### 标注要求

Product 产品	Environmental protection use period (years) 环境保护使用期限 (年)	Logo 标志
This Exfo product 本 EXFO 产品	10	
Battery <sup>a</sup> 电池 <sup>a</sup>	5	

a. If applicable.  
如果适用。

P/N: 1062089

[www.EXFO.com](http://www.EXFO.com) · [info@exfo.com](mailto:info@exfo.com)

<b>CORPORATE HEADQUARTERS</b>	400 Godin Avenue	Quebec (Quebec) G1M 2K2 CANADA Tel.: 1 418 683-0211 · Fax: 1 418 683-2170
<b>EXFO AMERICA</b>	3400 Waterview Parkway Suite 100	Richardson, TX 75080 USA Tel.: 1 972-761-927 · Fax: 1 972-761-9067
<b>EXFO EUROPE</b>	Omega Enterprise Park, Electron Way	Chandlers Ford, Hampshire S053 4SE ENGLAND Tel.: +44 2380 246810 · Fax: +44 2380 246801
<b>EXFO ASIA-PACIFIC</b>	100 Beach Road, #22-01/03 Shaw Tower	SINGAPORE 189702 Tel.: +65 6333 8241 · Fax: +65 6333 8242
<b>EXFO CHINA</b>	Beijing Global Trade Center, Tower C, Room 1207, 36 North Third Ring Road East, Dongcheng District	Beijing 100013 P. R. CHINA Tel.: +86 (10) 5825 7755 Fax: +86 (10) 5825 7722
<b>EXFO SERVICE ASSURANCE</b>	270 Billerica Road	Chelmsford MA, 01824 USA Tel.: 1 978 367-5600 · Fax: 1 978 367-5700
<b>EXFO NETHAWK</b>	Elektroniikkatie 2	FI-90590 Oulu, FINLAND Tel.: +358 (0) 403 010 300 Fax: +358 (0) 8 564 5203
<b>TOLL-FREE</b>	(USA and Canada)	1 800 663-3936

© 2011 EXFO Inc. All rights reserved.  
Printed in Canada (2011-12)



**EXFO**  
EXPERTISE REACHING OUT